

## Specifications

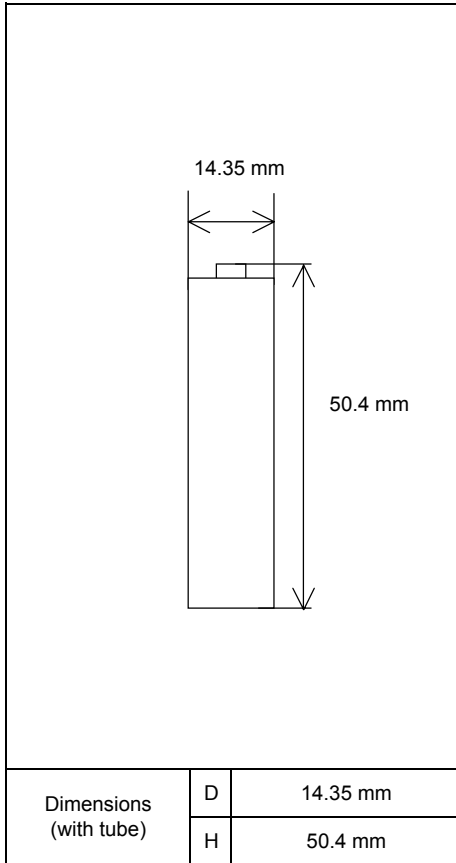

Type : Nickel-Metal Hydride Battery		Size : AA Consumer Type
Capacity <sup>1)</sup>	Typical	2500mAh
	Minimum	2300mAh
Nominal Voltage		1.2V
Charging Current x Time	Fast Charge <sup>2)</sup>	2500mA × 1.1h
Ambient Temp.	Charge Condition	Fast Charge <sup>2)</sup>
	Discharge Condition	0°C - 40°C
	Storage Condition	0°C - 50°C
Storage Condition	Less than 30days	-20°C - 50°C
	Less than 90days	-20°C - 40°C
	Less than 1year	-20°C - 30°C
Internal Impedance <sup>3)</sup> (after discharge to E.V.=1.0V)		Approx. 25mΩ (at 1000Hz)
Weight <sup>4)</sup>		Approx. 30g
Size <sup>4)</sup> : (Diameter) x (Height)		14.35(D) x 50.4(H) mm

- 1) Single cell capacity under the following condition.  
Charge : 250mA×16h, Discharge : 500mA(E.V.=1.0V) at 20°C
- 2) Use recommended charging system.
- 3) After a few charge and discharge cycles under the above 1) condition.
- 4) With tube.

## Typical Characteristics

### Charge

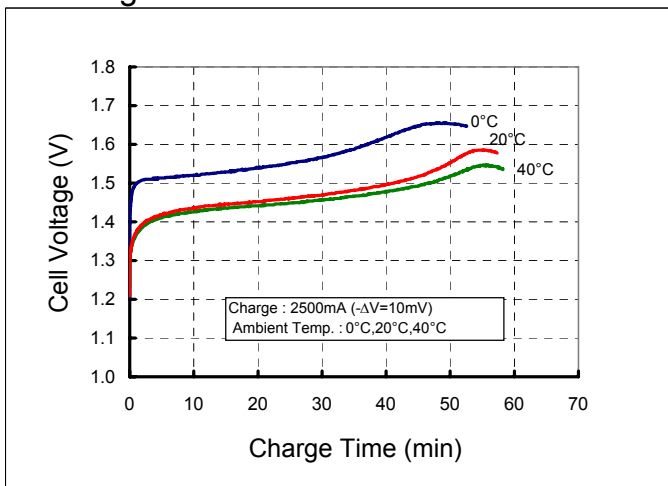

### Discharge

